

**VOLANTEX** RC

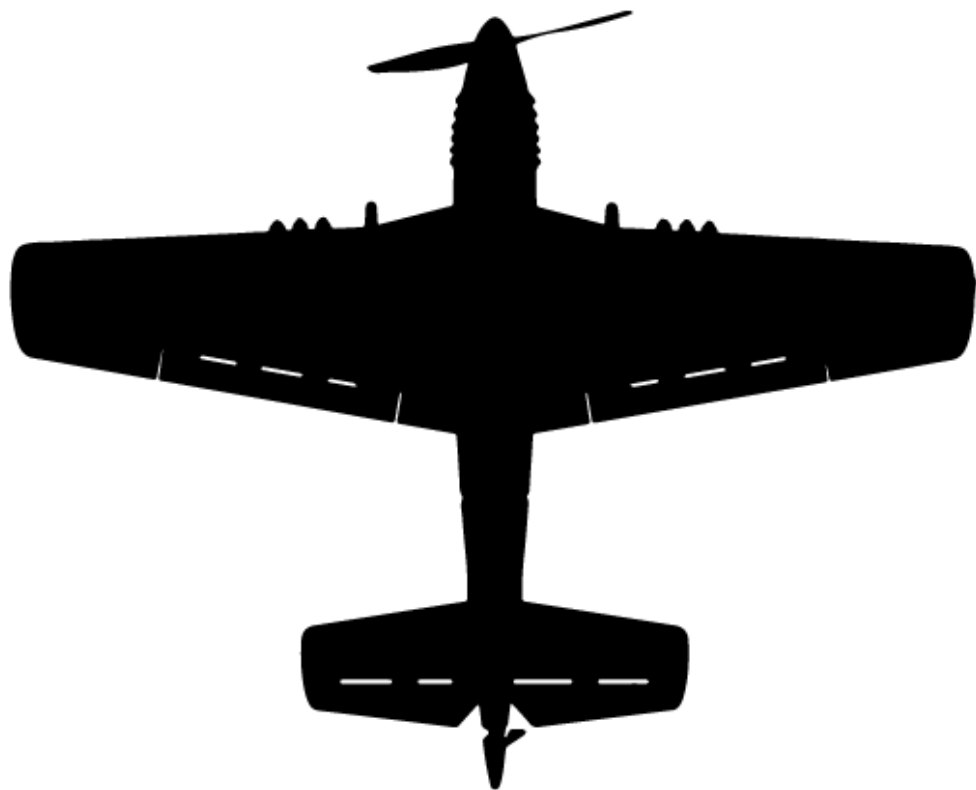

***LEGEND WARBIRD SERIES  
USER MANUAL***

76111  
v.01.2025

## WARNING

The following terms are used throughout the product literature to indicate various levels of potential harm when operating this product.

**CAUTION:** Procedures, which if not be properly followed, is able to create a possibility of physical property damage AND or possibility of injury.

 Read the **ENTIRE** instruction manual to become familiar with the features of the product before operating. Fail to operate the product correctly can result in damage to the product, personal property and cause serious injury.

 This is a sophisticated hobby product and **NOT a toy**. It must be operated with caution and common sense and requires some basic mechanical ability. Fail to operate this Product in a safe and responsible manner could result in injury or damage to the product or other property. This product is not intended for use by children without direct adult supervision. Do not attempt to disassemble, use with incompatible components or augment product in any way without the approval of VolantexRC Co., Ltd.. This manual contains instructions for safety, operation and maintenance. It is essential to read and follow all the instructions and warnings in the manual, prior to assembly, setup or use, in order to operate correctly and avoid damage or serious injury. Age Recommendation: Not for children under 14 years. This is not a toy.

## Safety Precautions

---

As the user of this product, you are solely responsible for operating in a manner that does not endanger yourself and others or result in damage to the product or the property of others.

- Always ensure all batteries have been properly charged before using the vehicle.
- Always check all servos and their connections prior to each run.
- Never operate your vehicle near spectators, parking areas or any other area that could result in injury to people or damage of property.
- Never operate your vehicle during adverse weather conditions. Poor visibility can cause disorientation and loss of control of your vehicle.
- Never point the transmitter antenna directly toward the vehicle. The radiation pattern from the tip of the antenna is inherently low.
- If at any time during the operation of your vehicle you observe any erratic or abnormal operation, immediately stop operation of your vehicle until the cause of the problem has been ascertained and corrected.

## Battery Usage & Charging Warnings

---

**CAUTION:** All instructions and warnings must be followed exactly. Mishandling of Li-Po/Li-Ion/Ni-Mh batteries can result in fire, personal injury, and/or property damage.

- The battery charger included with your plane(if there be) is designed to safely balance and charge the specific Li-Po/Li-Ion/Ni-Mh battery.

- By handling, charging or using the included battery, you shall assume all risks associated with Li-Po/Li-Ion/Ni-Mh battery.
- If at any time the battery begins to balloon or swell, discontinue use immediately. If charging or discharging, you should discontinue and disconnect. Continue to use, charge or discharge a battery that is ballooning or swelling can result in fire.
- Always store the battery at room temperature in a dry area for best results.
- Always transport or temporarily store the battery in a temperature range of 40-120 Fahrenheit degrees (5-49 degrees centigrade). Do not store battery or your plane in a car or direct sunlight. If stored in a hot car, the battery can be damaged or even cause fire.
- Always charge a battery away from flammable materials.
- Always inspect the battery before charging and never charge damaged batteries.
- Always disconnect the battery after charging, and allow the charger cool before next charge.
- Always constantly monitor the temperature of the battery pack while charging.
- **ONLY USE A CHARGER SPECIALLY DESIGNED TO CHARGE SPECIFIC BATTERIES.**
- Never discharge Li-Po cells till below 3V under load.
- Never cover warning labels with hook or loop strips.
- Never leave charging batteries unattended.
- Never charge batteries outside recommended levels.
- Never attempt to dismantle or alter the charger.
- Never allow minors to charge battery packs.
- Never charge batteries in extremely hot or cold places (recommended between 40-120 Fahrenheit degrees / 5-49 degrees centigrade) or in direct sunlight.

## Box Contents

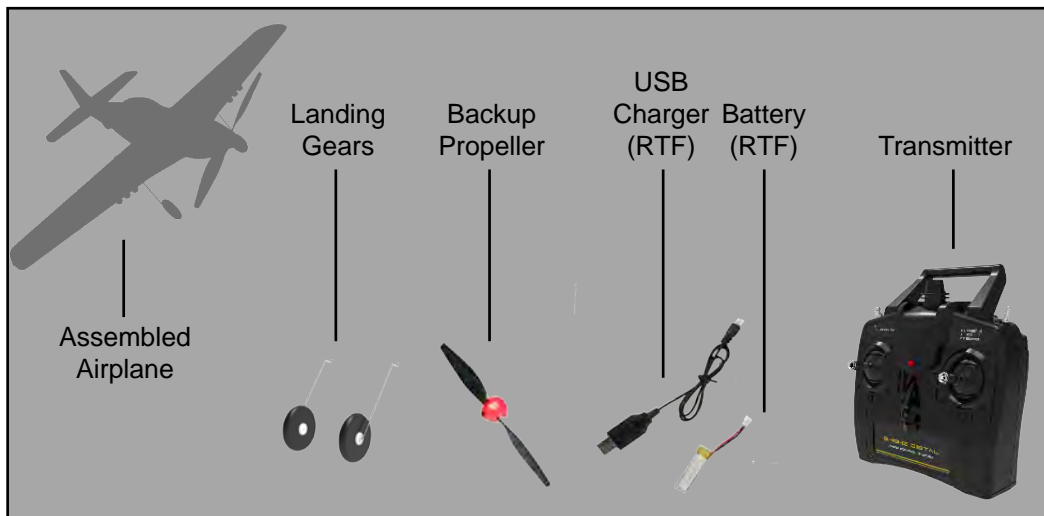

**NOTE:** The actual product may vary slightly from manual according to the model you purchased.

## Charging Instruction

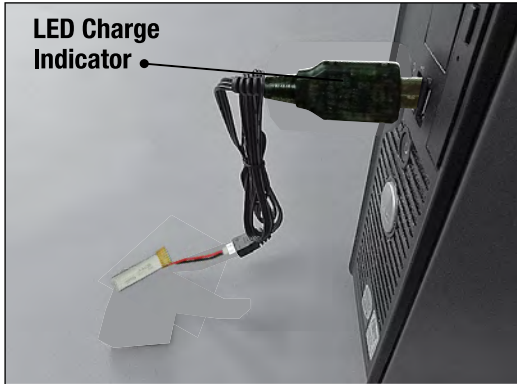

1. Unplug the battery from your plane.
2. Carefully plug the charger into the USB port on your computer or USB adapter.
3. Connect battery into the charger.
4. The charging process takes about 3 hours. For safety reasons, never charge the battery for longer than 4 hours. While charging, the red LED indicator will be flashing. When the charging is finished, the red LED will be off.

## Setup Instruction

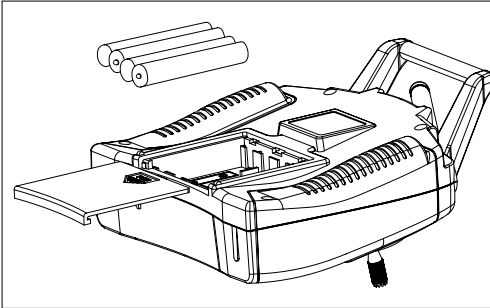

1. Install 4 AA batteries(not included) in the transmitter.

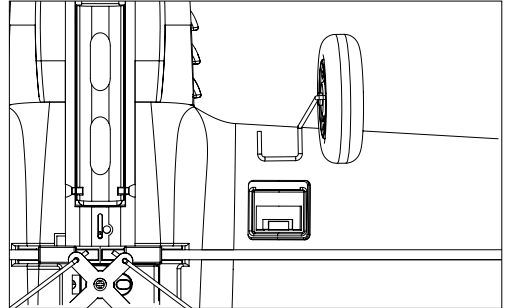

2. Plug the landing gears into the position on the mainwing as shown above.

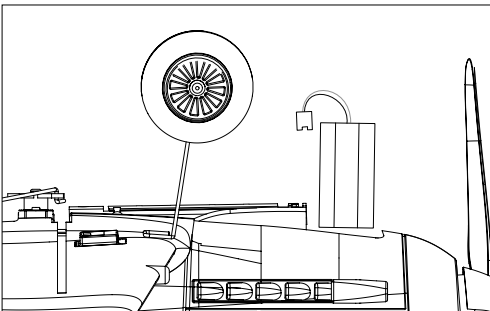

3. Connect the battery to the receiver, then put the battery into the cabin as shown.

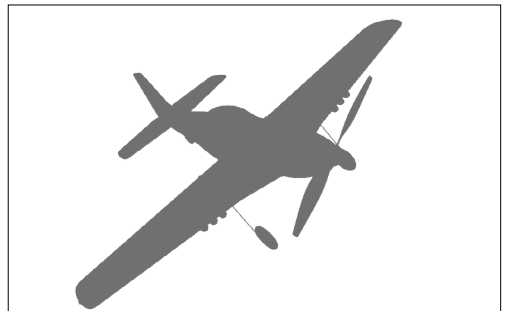

4. Setup is done. Make sure you read and follow all instructions in this manual before start flying the airplane.



## Center Control Surfaces

**NOTE: Keep the X-PILOT switch off (manual mode) before you operate the steps below. See more information in "X-PILOT switch" section.**

With the transmitter turned on and the battery connected to the ESC (and installed in the battery compartment), it is now possible to check the center of all control surfaces.

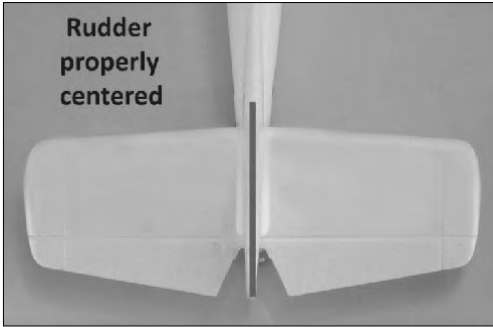

Observe the rudder to ensure it is properly centered as shown above.

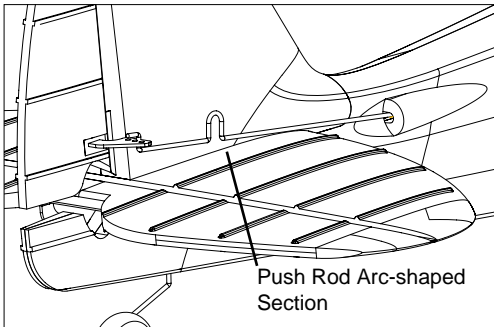

If the rudder is angled off to the right or left, adjust the push rod by its arc-shaped section slightly, making sure the rudder is properly centered.



Then observe the elevator to ensure it is properly centered as shown above.

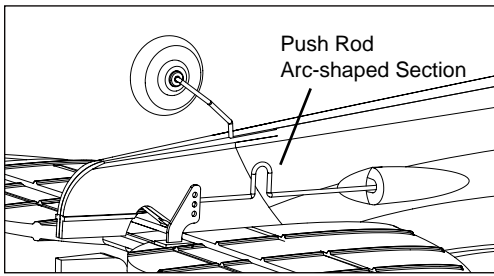

If the elevator is angled off to the upper or lower position, adjust the push rod by its arc-shaped section slightly, making sure the elevator is properly centered.

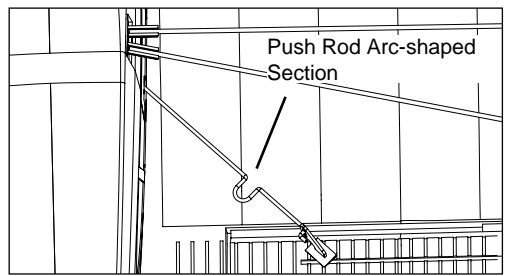

If the aileron is angled off to the upper or lower position, adjust the push rod by its arc-shaped section slightly, making sure the aileron is properly centered.

## Transmitter Instruction

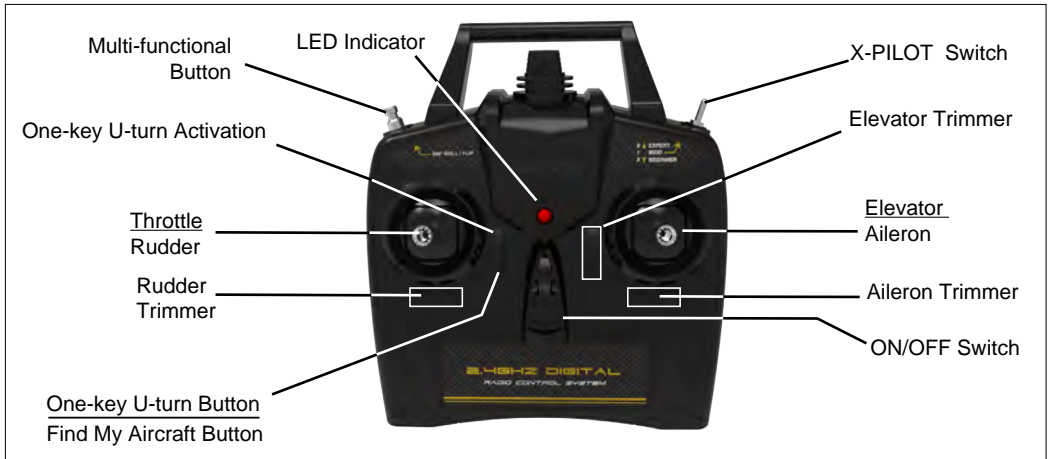

## X-PILOT Switch

- 0 - Away from you - Manual / X-PILOT Off (EXPERT)
- 1 - At the intermediate - Soft X-PILOT Assit (MIDD)
- 2 - Towards you - Strong X-PILOT Assit (BEGINNER)



The airplane comes with pre-installed X-PILOT to help control flying easily. The switch is with 3 levels to control the X-PILOT. To turn on the X-PILOT, switch to upper position(towards you). To turn off the X-PILOT, switch to lower position(away from you).

**CAUTION:** It is strongly suggested to turn on X-PILOT while flying the airplane.

## Binding Instruction

---

1. Keep the transmitter switched OFF, throttle joystick at bottom position.

**NOTE:** Keep X-PILOT switch at Middle or Beginner position.

**NOTE:** Keep the plane still in a calm environment for calculating the X-PILOT.

2. Connect the battery to the plane, then turn on the transmitter within 5 seconds.

3. The receiver LED will flash for 3-8 seconds to bind automatically.

4. After the receiver LED stop flashing, it means the binding process is done.

**CAUTION:** Do **NOT** operate around people or property, otherwise it may cause serious damage!

## Arm the Throttle

---

To prevent from damages, the throttle channel is locked each time when powering on your transmitter. Follow below instruction to unlock the throttle.

**CAUTION:** Keep the propeller in distance for your safety.

Turn the throttle stick up to max position until you hear a "beep" sound. Then turn the throttle stick down to min position until you hear a "beep" sound.

Now the throttle is unlocked.

## Servo Lock

---

When the transmitter stops operation for over 30 seconds, the servos will be locked up, to avoid over current due to stuck by obstacle. Pull up the throttle to unlock the servos.

## Signal Loss Alert

---

When the aircraft flies too far away from signal range, or there is signal interference nearby, both the transmitter and the receiver will have 4 beeps in a series to alert. Return the airplane back to safe range and area.

## Flight Battery Low Power Alert

When the flight battery is low power, both the transmitter and the receiver will have continuous beeps to alert. Return the aircraft to replace the flight battery immediately.

## Transmitter Battery Low Power Alert

When the transmitter batteries are low power, the transmitter LED will keep flashing with 1 beep in a series to alert. Return the aircraft, replace the transmitter batteries.





## Digital Trims



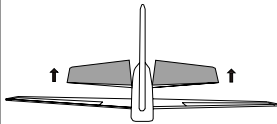

---

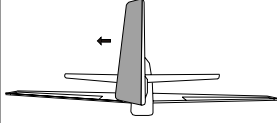
Digital trims allow to adjust the centered position of aileron, rudder or elevator hinge. Each time when a trimmer is moved, the servo output will change certain angle. If the trimmer is held, the output will scroll in that direction until the trimmer is released or the output reaches its end. When you hear a short beep, it means the trimmer is centered.

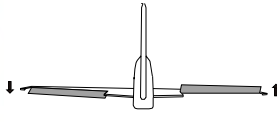

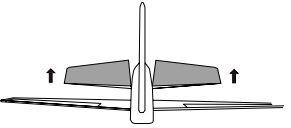
## Channels Reactions Checking

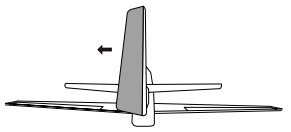
Transmitter Operaton	Reaction
	
	
	

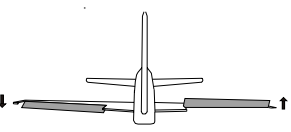
Swing The Plane	X-PILOT Reaction
	
	
	

Place your plane in a neutral position, follow below steps to check the channels reactions. Move the sticks(except the throttle stick) to see if all servo surfaces react correctly as shown in the left diagram(left throttle for example). Swing your plane to check if all servo surfaces react correctly as shown in the right diagram.

## One-key Aerobatics Instruction

The one-key aerobatics feature allows beginner pilot to perform aerobatic actions by simply pressing the button on transmitter.

During flight, under X-PILOT control mode, press the one-key aerobatics button, the transmitter will beep several times. During the beeping, simply move the aileron stick to either direction for auto-roll. Or move the elevator stick to either direction for auto-flip.



## X-PILOT System Calibration

1. Turn the throttle stick to min position.
2. Power on the transmitter and the receiver.
3. Do **NOT** unlock the throttle.
4. Keep the sticks as above picture for several seconds.
5. When you hear a "beep" sound, it means the X-PILOT system is calibrated based on the horizontal level you are keeping it.



**NOTE:** The aircraft is calibrated in factory, you don't need the calibration normally. We suggest that you only calibrate when you are sure that the stabilization system is not working correctly.

## One-key Takeoff

---

The airplane comes with one-key take off function, which enable the plane to take off automatically and hover in the air, until any operation on transmitter to exit. Follow below steps to use this function.

1. Turn the X-PILOT switch to beginner / intermediate mode.
2. Arm the throttle (See "Throttle Unlock" section on page 7).
3. Keep the throttle at zero (down) position.
4. Hold your airplane to take-off attitude, press the one-key takeoff button. The transmitter will start beeping.
5. Pull throttle stick up to max, the propeller will start spinning.

During the beeping, throw out the airplane with slightly up angle. The airplane will take off automatically to a proper altitude, and hover in a certain area.

**Note:** It is important to keep the throttle at down position before pressing the button at the left shoulder of transmitter. Otherwise it will react as one-key aerobatic function.

**Note:** You must operate step 5 during the transmitter beeping. Otherwise it will exit the one-key takeoff mode.

6. Any operation on the transmitter channel will exit the hover and get the aircraft back to your control.



## One-key U-turn Instruction

---

The airplane comes with one-key U-turn function, which enable the plane to U-turn by the opposite direction that the airplane takes off.

Follow below steps to activate the function.

1. Place your plane heading to the take-off direction.
2. Do **NOT** unlock the throttle, press the activation button and hold for several seconds until you hear a "beep" sound, the rudder surface will respond, meaning the one-key U-turn function is now activated.

**NOTICE:** Every time when you power on the plane, it requires to activate the one-key U-turn function.

To use this function during flight, press the one-key U-turn switch button, the plane will turn around automatically, back to the opposite direction where it takes off.

To quit, just press again the switch button, or control any servo stick (rudder/elevator), the plane will back to your control immediately. No matter you fly the plane under manual control or X-PILOT assist mode, when you turn on the one-key U-turn function, the plane will enter X-PILOT assist mode automatically to help stably flying back. When you quit this function, the airplane will back to the what the control mode it was.

**CAUTION:** This function is bound to the receiver, instead of to the transmitter, which means the plane will U-turn **ONLY** to the opposite direction that the plane takes off. It also means when the plane U-turns and passes the position where you activated the function, the one-key U-turn function will **NOT** U-turn the plane back to the take-off position.

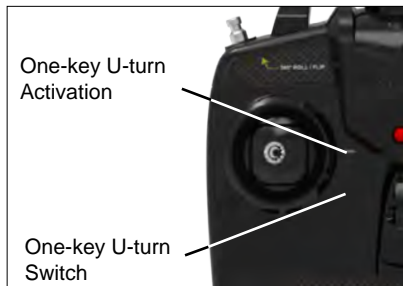

## Find My Aircraft

When the aircraft is missing but with power on, press and hold the find my aircraft button for 3 seconds until there is a beeping sound, it means the find my aircraft is activated. The aircraft will keep 4 beepings in a series to indicate its location.



## Propeller Saver Instruction

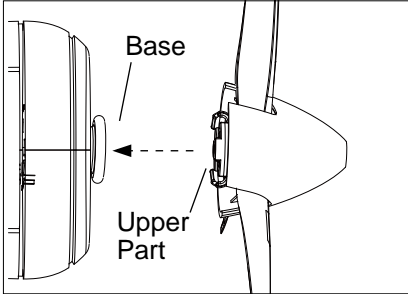

The propeller saver keeps the propeller from damage, and prevent the electronic components from over current. When the airplane hits any obstacle, the propeller will loose from the base. To install the propeller back to the base, insert the upper part centerly through the motor shaft, and hearing a "click" sound to ensure it is secured.

## Propeller Replacement

Follow below steps to replace broken propeller and shaft adaptor. You will need help of a Philips screw driver and pliers(not included).

1. Take off the spinner and propeller by loosen the screw with a Philips screw driver.
2. Take off the shaft adaptor carefully. If it is too tight, use pliers to help.
3. Replace any part broken.
4. Install all parts back by inverted orders to finish replacement.

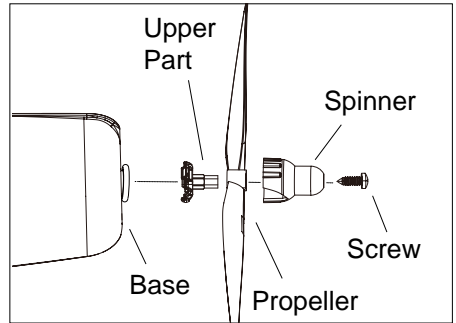

## Power System Replacement

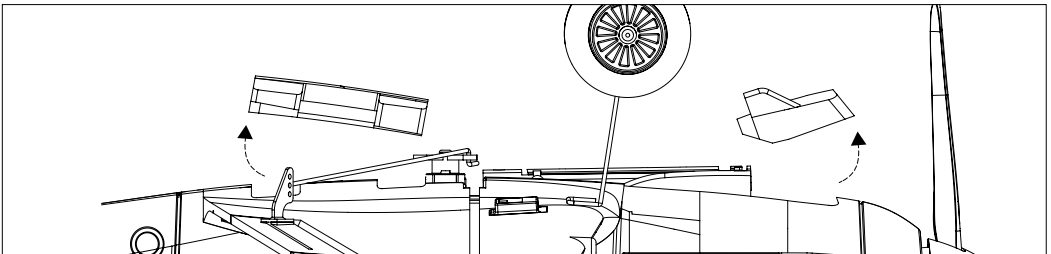

1. Take off the cover in the head of fuselage to replace the motor, or the cover in the middle of fuselage to replace the receiver. It is no need of tool to take off the covers.

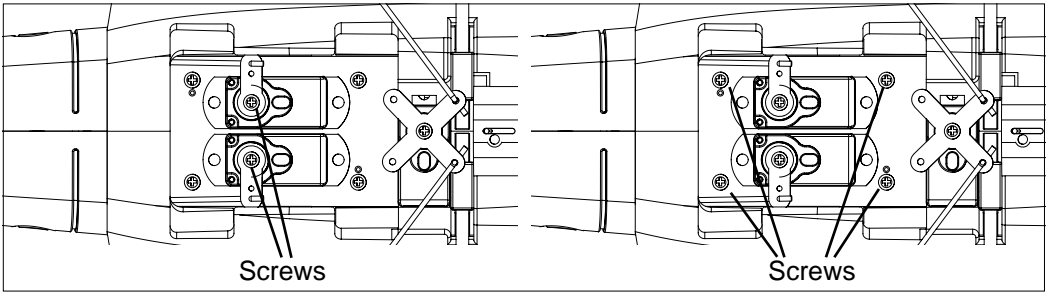

2. Follow below steps to replace the receiver.
  - a. Loosen the screws of servo horns, take the servo horns off.
  - b. Unplug the motor cable and the mainwing servo cable. You may need to record the direction of cable plugs.
  - c. Loosen the screws as shown to take off the the receiver.

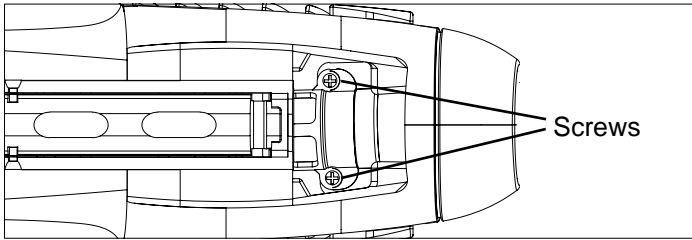

3. Follow below steps to replace the motor.
  - a. Unplug the motor cable from receiver board. You may need to record the direction of cable plug.
  - c. Loosen the screws as shown to take off the the motor.

## Compatible Protocol Instruction

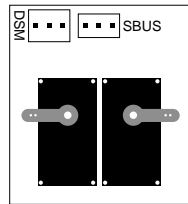
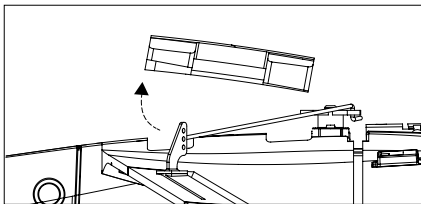

The aircraft comes with compatible protocol slots that can be bound to transmitters that use DSM or SBUS protocol. To use it, follow the below steps.

1. Take off the receiver cover as shown.
2. Find the DSM or SBUS protocol slot on the receiver board. Plug in your satellite receiver to the certain slot as marked.
3. Turn on your transmitter with certain protocol to bind.

Note: The compatible protocol will allow you to use your own radio system, and it will replace the factory transmitter to work.

## Flight Checklist

---

NOTE: This checklist is NOT intended to replace the content included in this instruction manual. Although it can be used as a quick start guide, we strongly suggest that read all though the manual completely before proceeding.

- Ensure the throttle control stick is at bottom position before connecting the battery.
- Fly the model(hand-launch or take off from a flat/level surface).
- Land the model on a flat/level surface.
- Unplug the battery.
- Always turn off the transmitter last.

## Find a Flight Field

---

Based on the size and weight of the plane it is typically considered to be a "park flyer" class airplane. As a result it is best to fly the plane at a local park, schoolyard, flying field or other area that is large enough and free of people and obstructions. We recommend an area the size of at least one football/soccer field. However, even larger areas are better suited and preferred especially when learning how to fly. Do NOT fly in parking lots, crowded neighborhood areas or in areas that are not free of people or obstructions.

We also suggest flying over grass as it is a much more forgiving surface that causes less damage in the unfortunate event or a crash. Short grass is better for takeoffs and landings as grass that is too long can cause the airplane to nose-over/flip and be damaged. An ideal flying area allows for takeoffs and landings on a smoother surface(such as asphalt) and flying over grass.

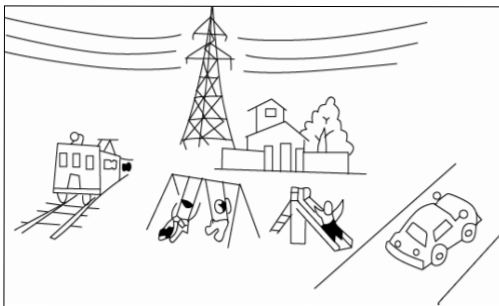
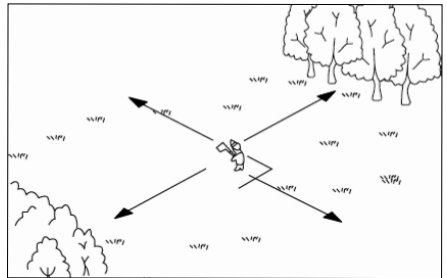

Fly in spacious ground without obstacles and boskage.

Never fly the plane near highway, railway, high tension line, crowded people, flying area and residential area.

NOTE: The plane is designed to be flew outdoors only.

## Flying Conditions

---

It is typically best to fly on days that are calm without wind, especially when learning how to fly. It is strongly suggested flying only in calm conditions until you are familiar with the controls and handling of the model. Even light winds can make it much more difficult to learn to fly, and in some cases can even carry the model beyond your line of sight.

Also, if you are a first-time or low-time pilot, we highly recommend that allow a more experienced pilot to test fly and properly trim the model before attempting your first flight. A proven flyable and properly trimmed model is significantly easier and more enjoyable to fly.